

Dual Pane Section Drawings

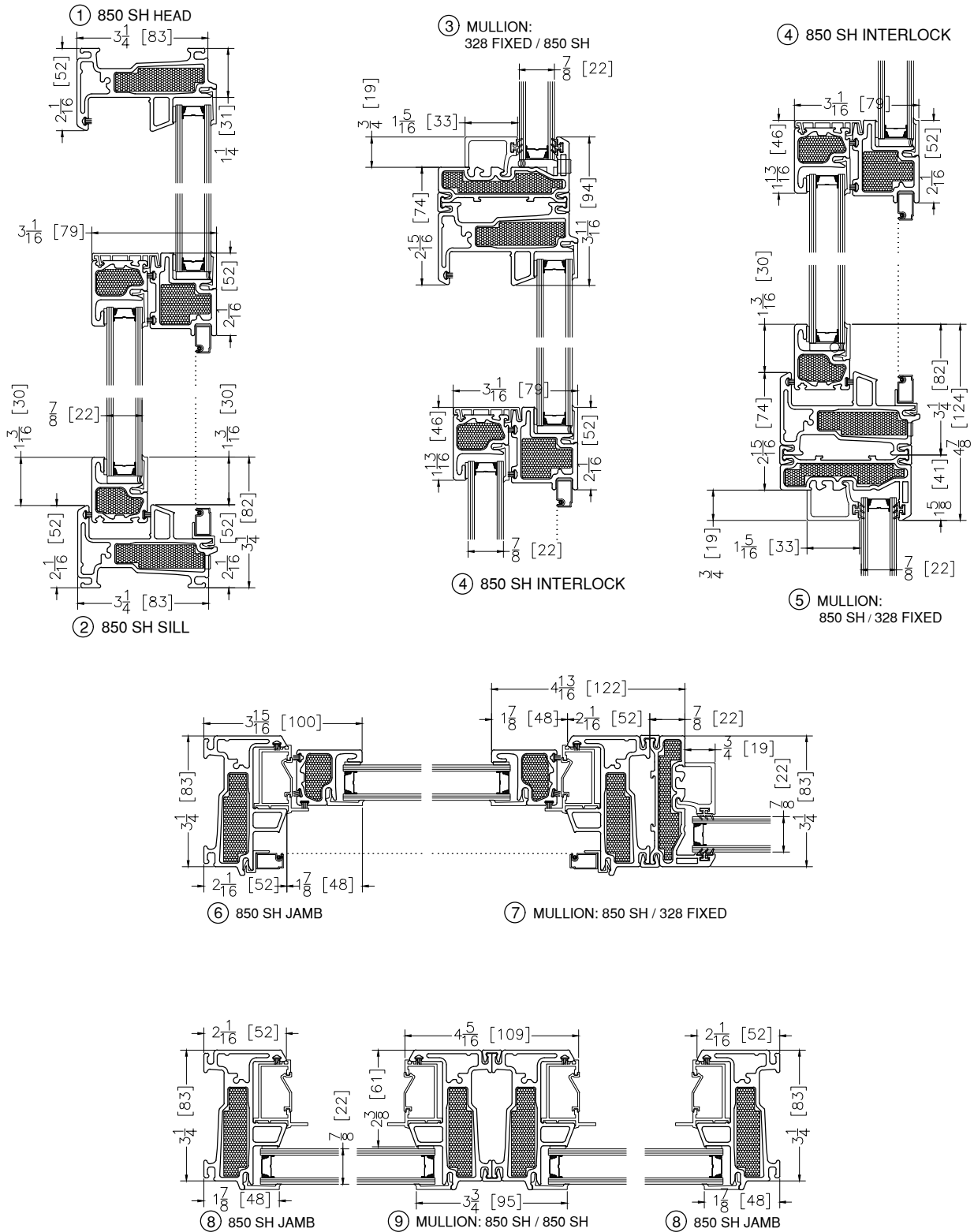

Typical Elevations

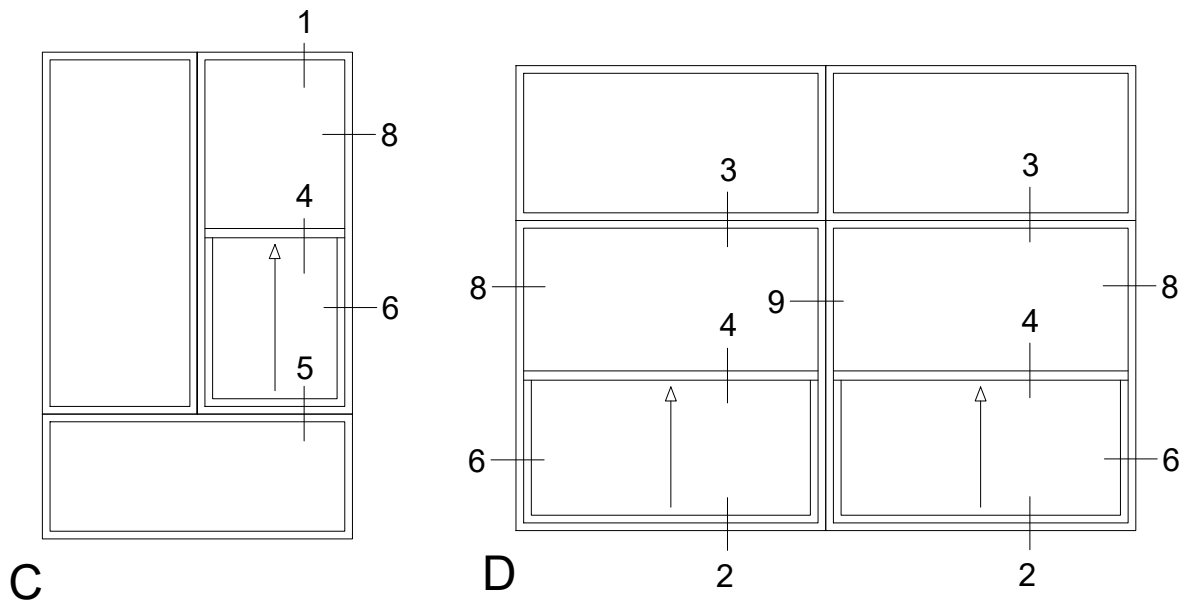
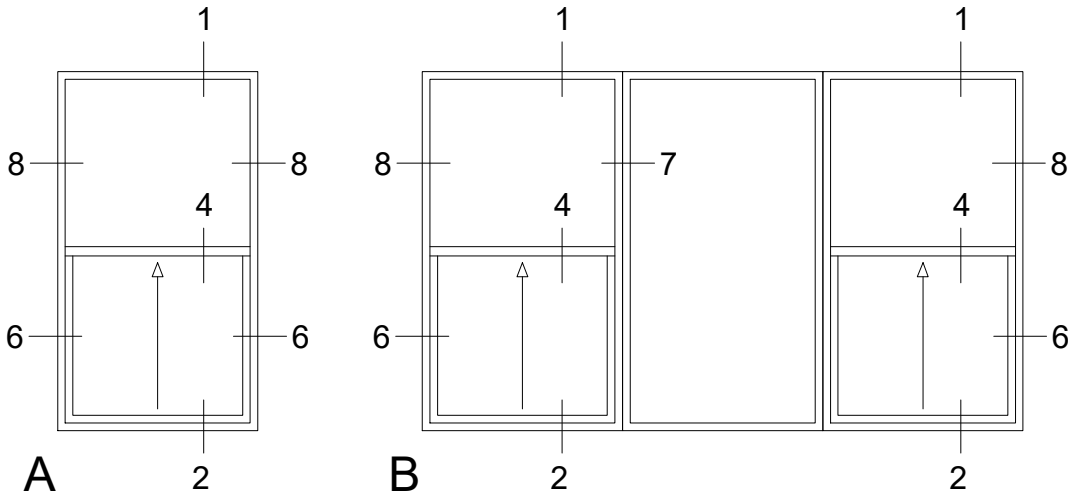

Installation Flange

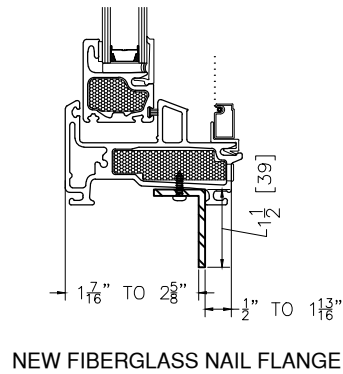

OPTIONAL 250 PANNING OR
350 PANNING PERIMETER

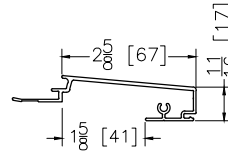

250 PANNING PERIMETER (NO NAIL FLANGE)

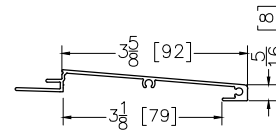

350 PANNING PERIMETER (NO NAIL FLANGE)

Installation Clips

- A. CORNER ANCHORS – SECURE APPROXIMATELY 4" FROM THE CORNERS
- B. PERIMETER ANCHORS – SPACING SHOULD NOT EXCEED 24" APART CENTER TO CENTER
- C. MULLION AND TRANSOM ANCHORS – ALWAYS ANCHOR WITHIN 4" OF MULLION OR TRANSOM

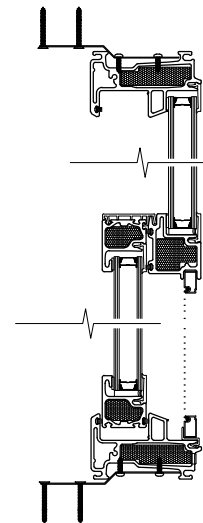
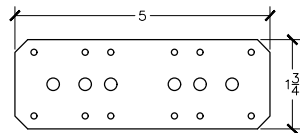
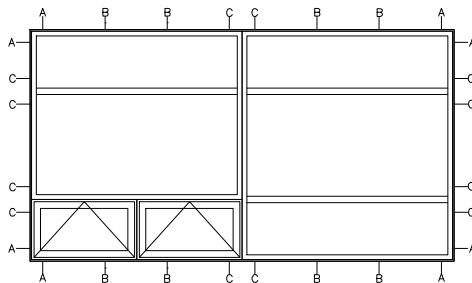

Interior Options

PACIFIC COAST HEMLOCK / OAK
WOOD OR CELLULAR PVC
JAMB LINER

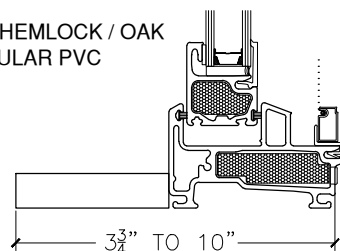

NEW DUAL PURPOSE
1/2" AND 5/8" OR 3/4"
DRYWALL RETURN
U-CHANNEL

